

receptek

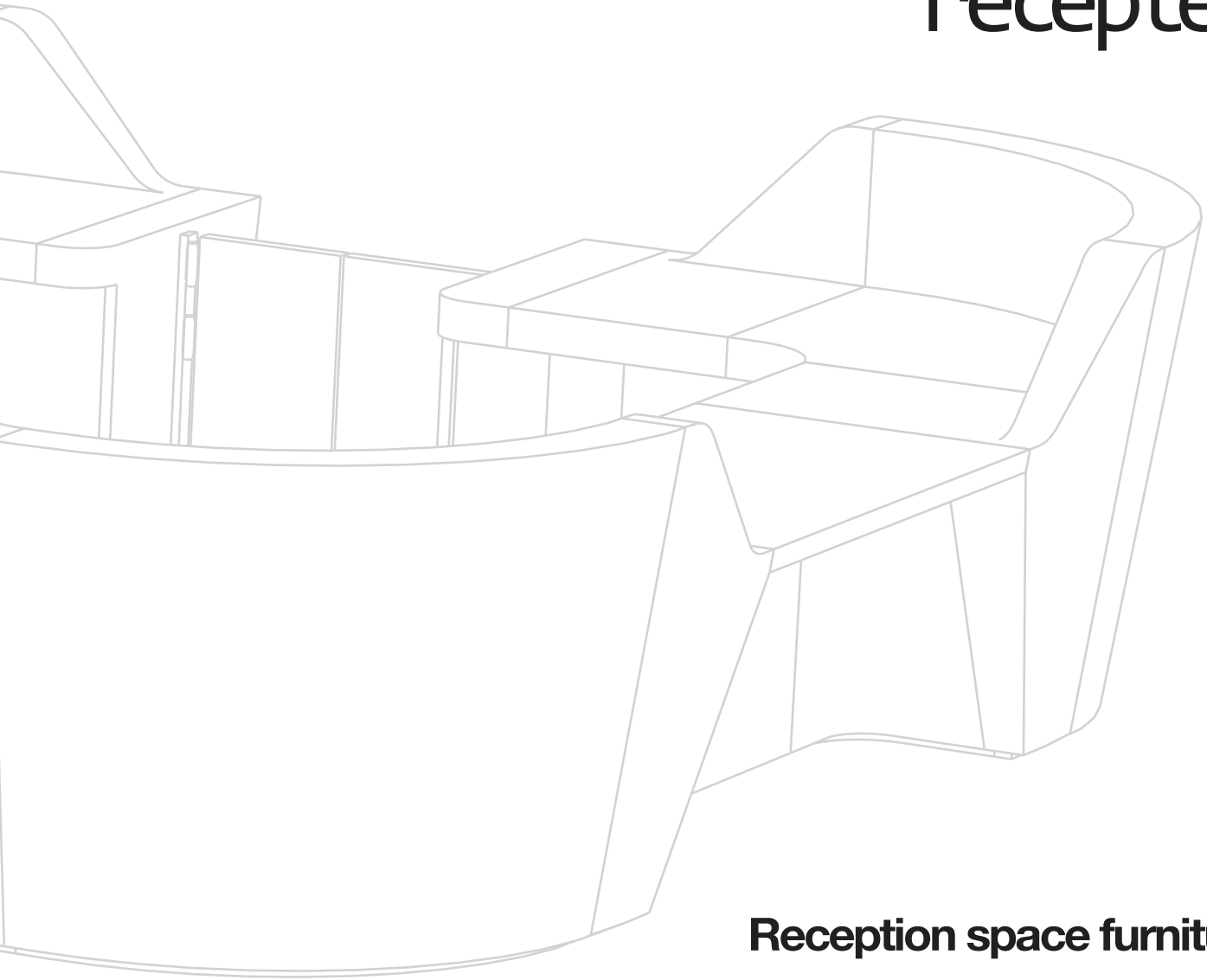

**Reception space furniture**

# HQ

## **“Please report to HQ”. “Yes Sir”. This product commands respect, and rightly so!**

Aside from its ability to provide the ‘centre point’ in any environment, this product provides the specifier with huge flexibility of design. As with most of our so called modular products HQ is only presented in module form for the purpose of design and is offered only in Solid Surface (Corian) so as to maintain the seamless flow that is such an intrinsic part of the design.

### **Designers Comment:**

“Solid Surface (Corian) has provided designers with great creativity over the last few years with the likes of the late Zaha Hadid pushing the boundary’s with some extraordinary ideas. However, these ‘one off’ works of art come with a premium price tag. HQ offers a huge degree of design flexibility whilst retaining a firm hold on the costs. What a delight.”

### **Key features**

Solid Surface Material (Corian)

Modular on specification, seamless on installation

Easy to specify modular components CAD and BIM files available

Three height options of 750 mm and 1100 mm as standard

DDA modules available

Branding, sign-in platform and storage units available as options

LED light trough

Various colour options available

Available in 4–6 weeks



Southampton  
**SOLENT**  
University

# HQ Typical Configurations & Modules

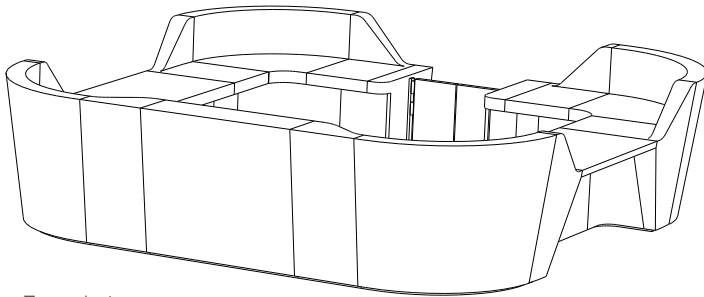

Example 1  
Made up of modules; HQ- S2D1 LH, HQ- IM4 1000, HQ- S2D2 RH, HQ- LM4 RH, HQ- L2H4 DDA RH, HQ- LM2 1000, HQ- L2H3 DDA RH, HQ- LM4 RH, HQ- L2H2 RH, HQ- EM2, HQ- GATE, HQ- EM1, HQ- L2H1 LH, HQ- CM3 LH, HQ- L2H4 DDA RH, HQ- LM2 1000, HQ- L2H3 DDA LH, HQ- CM3 LH

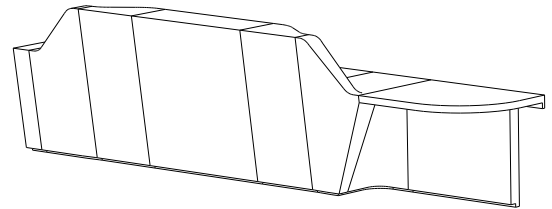

Example 2  
Made up of modules; HQ EM1, HQ S2D1 LH, HQ IM4 1000, HQ S2D2 RH, HQ L2H2 RH, HQ EM4 DDA

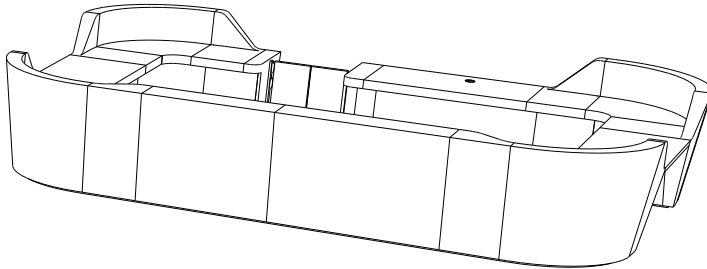

Example 3  
Made up of modules; HQ- S2D1 LH, HQ- IM4 1000, HQ- S2D2 RH, HQ- LM4 RH, HQ- L2H4 DDA RH, HQ- LM2 1000, HQ- L2H3 DDA RH, HQ LM4 RH, HQ- L2H2 RH, HQ- EM2, HQ- GATE, HQ- EM1, HQ- L2H1 LH, HQ- CM3 LH, HQ- L2H4 DDA RH, HQ- LM2 1000, HQ- L2H3 DDA LH, HQ- CM3 LH, HQ- IM4 1500, HQ- IM1 1500

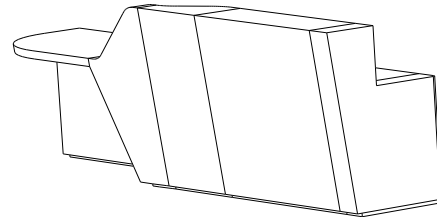

Example 4  
Made up of modules; HQ- EM3 DDA, HQ- L2H3 DDA LH, HQ- S2D1 LH, HQ IM4 1000, HQ EM6

# HQ Modules

## End modules

Module Name:  
**LH Low End**  
Module Code:  
**HQ EM1**  
Module Size:  
**150x750x750mm**

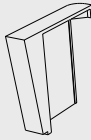

Module Name:  
**RH Low End**  
Module Code:  
**HQ EM2**  
Module Size:  
**150x750x750mm**

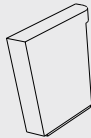

Module Name:  
**LH DDA End**  
Module Code:  
**HQ EM3DDA**  
Module Size:  
**1000x750x750mm**

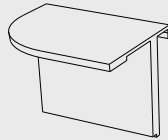

Module Name:  
**RH DDA End**  
Module Code:  
**HQ EM4DDA**  
Module Size:  
**1000x750x750mm**

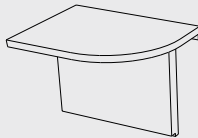

## Intermediate modules

Module Name:  
**Low Intermediate**  
**Module 1000mm**  
Module Code:  
**HQ IM1 1000**  
Module Size:  
**1000x750x750mm**

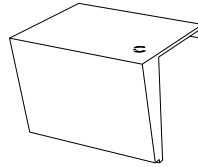

Module Name:  
**Low Intermediate**  
**Module 1200mm**  
Module Code:  
**HQ IM1 1200**  
Module Size:  
**1200x750x750mm**

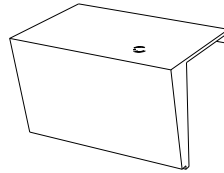

Module Name:  
**Low Intermediate**  
**Module 1500mm**  
Module Code:  
**HQ IM1 1500**  
Module Size:  
**1500x750x750mm**

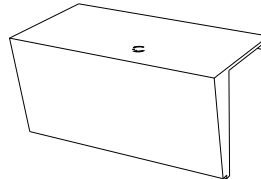

Module Name:  
**Low Intermediate**  
**DDA Module 1000mm**  
Module Code:  
**HQ IM2 1000**  
Module Size:  
**1000x750x750mm**

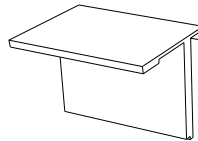

Module Name:  
**Low Intermediate**  
**DDA Module 1200mm**  
Module Code:  
**HQ IM2 1200**  
Module Size:  
**1200x750x750mm**

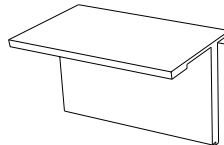

Module Name:  
**Low Intermediate**  
**DDA Module 1500mm**  
Module Code:  
**HQ IM2 1500**  
Module Size:  
**1500x750x750mm**

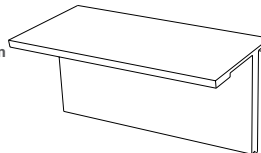

## Left hand modules

Module Name:  
**Low LH DDA Start**  
Module Code:  
**HQ DS1 LH**  
Module Size:  
**525x750x750mm**

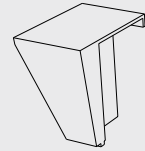

Module Name:  
**Low LH Corner**  
Module Code:  
**HQ CM1 LH**  
Module Size:  
**1000x900x750mm**

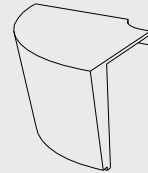

Module Name:  
**High LH Corner**  
Module Code:  
**HQ CM3 LH**  
Module Size:  
**950x750x1100mm**

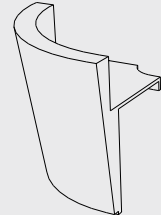

Module Name:  
**Low to High Section LH**  
Module Code:  
**HQ L2H1 LH**  
Module Size:  
**525x750x1100mm**

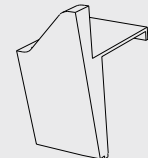

Module Name:  
**Low to High DDA**  
**Section LH**  
Module Code:  
**HQ L2H3 DDA LH**  
Module Size:  
**525x750x1100mm**

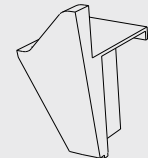

Module Name:  
**Intermediate Small to**  
**wide Console LH**  
Module Code:  
**HQ S2D1 LH**  
Module Size:  
**500x750x1100mm**

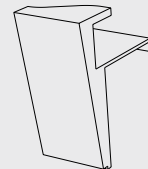

# HQ Modules

## Right hand modules

Module Name:  
**Low RH DDA Start**  
Module Code:  
**HQ DS2 RH**  
Module Size:  
**525x750x750mm**

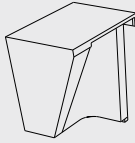

Module Name:  
**Low RH Corner**  
Module Code:  
**HQ CM2 RH**  
Module Size:  
**1000x900x750mm**

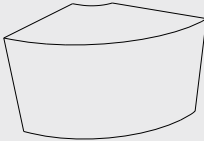

Module Name:  
**High RH Corner**  
Module Code:  
**HQ CM4 RH**  
Module Size:  
**950x750x1100mm**

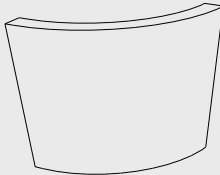

Module Name:  
**Low to High Section RH**  
Module Code:  
**HQ L2H2 RH**  
Module Size:  
**525x750x1100mm**

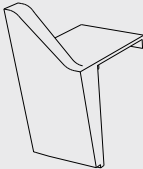

Module Name:  
**Low to High DDA Section RH**  
Module Code:  
**HQ L2H4 DDA RH**  
Module Size:  
**525x750x1100mm**

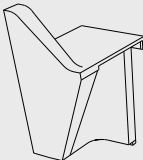

Module Name:  
**Intermediate Small to wide Console RH**  
Module Code:  
**HQ S2D2 RH**  
Module Size:  
**500x750x1100mm**

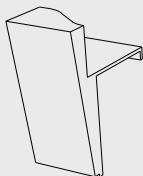

## Console top modules

Module Name:  
**Intermediate Small Console top 1000**  
Module Code:  
**HQ IM3 1000**  
Module Size:  
**1000x750x1100mm**

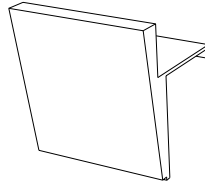

Module Name:  
**Intermediate Small Console top 1200**  
Module Code:  
**HQ IM3 1200**  
Module Size:  
**1200x750x1100mm**

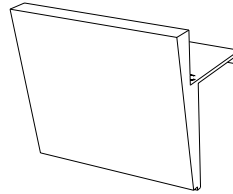

Module Name:  
**Intermediate Small Console top 1500**  
Module Code:  
**HQ IM3 1500**  
Module Size:  
**1500x750x1100mm**

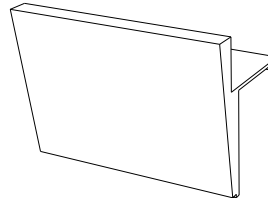

Module Name:  
**Intermediate Wide Console top 1000**  
Module Code:  
**HQ IM4 1000**  
Module Size:  
**1000x750x1100mm**

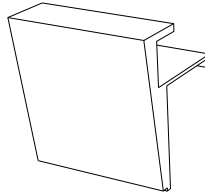

Module Name:  
**Intermediate Wide Console top 1200**  
Module Code:  
**HQ IM4 1200**  
Module Size:  
**1200x750x1100mm**

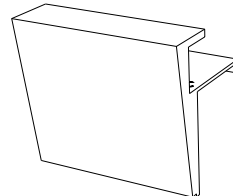

Module Name:  
**Intermediate Wide Console top 1500**  
Module Code:  
**HQ IM4 1500**  
Module Size:  
**1500x750x1100mm**

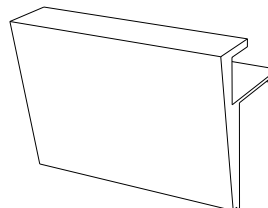

## End console modules

Module Name:  
**Small Console End LH**  
Module Code:  
**HQ SML EM 3**  
Module Size:  
**150x750x1100mm**

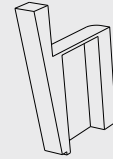

Module Name:  
**Small Console End RH**  
Module Code:  
**HQ SML EM 4**  
Module Size:  
**150x750x1100mm**

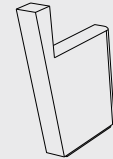

Module Name:  
**Deep Console End LH**  
Module Code:  
**HQ EM 5**  
Module Size:  
**150x750x1100mm**

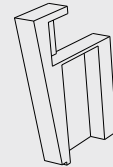

Module Name:  
**Deep Console End RH**  
Module Code:  
**HQ EM 6**  
Module Size:  
**150x750x1100mm**



# HQ Modules

## Storage modules

Module Name:  
**Double Door under  
counter storage**  
Module Code:  
**HQ DD Storage**  
Module Size:  
**800x550x700mm**

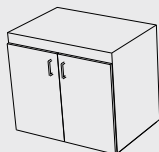

Module Name:  
**4no Draws**  
Module Code:  
**HQ Draws**  
Module Size:  
**675x550x700mm**



Module Name:  
**Printer Storage**  
Module Code:  
**HQ Printer**  
Module Size:  
**800x550x700mm**

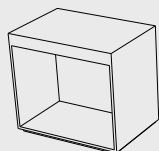

Module Name:  
**Gate**  
Module Code:  
**HG Gate**  
Module Size:  
**1000x100x700mm**

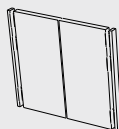







Products



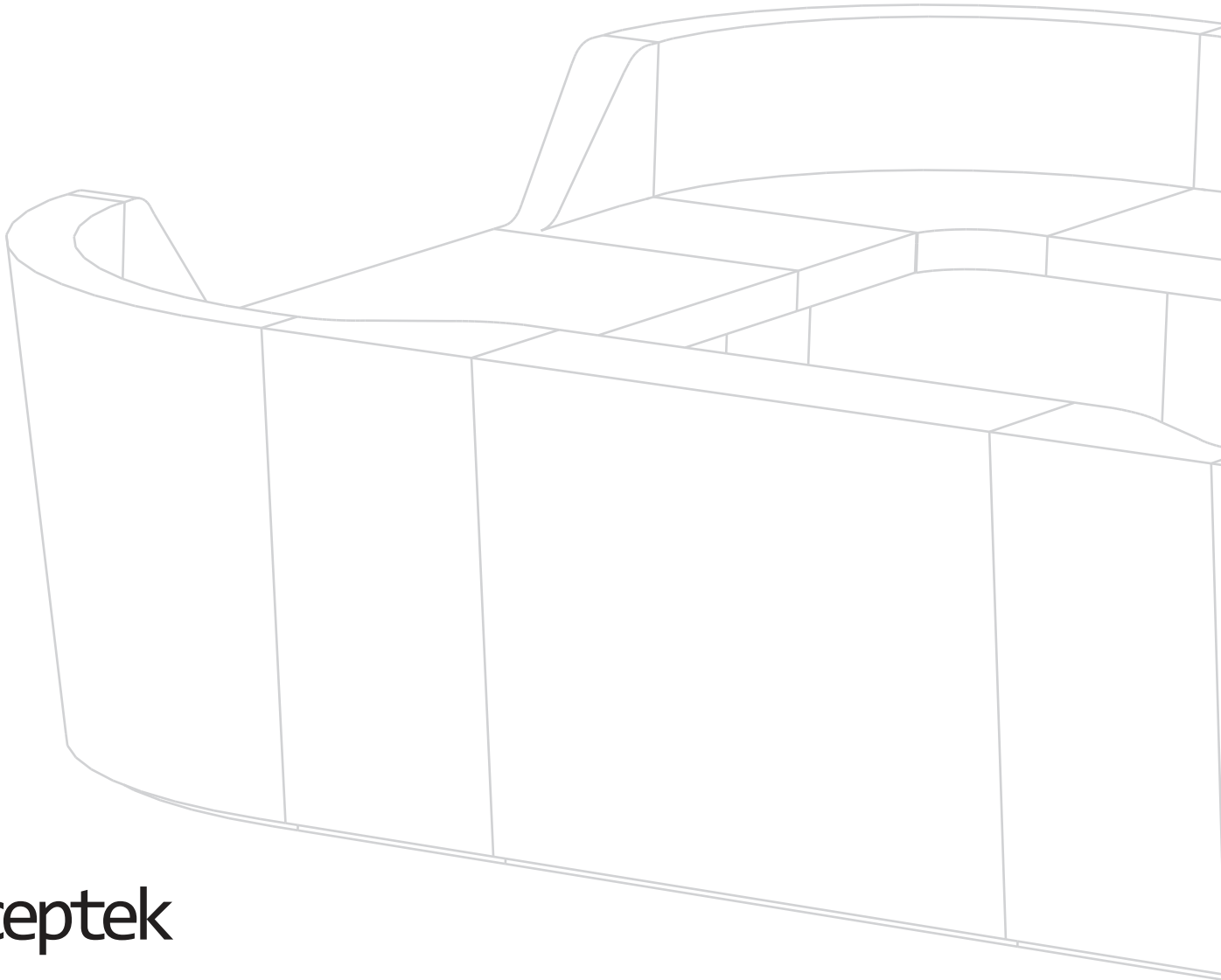

receptek

---

**Contact Us**

+44(0)1472 360 111  
hello@receptek.co.uk  
www.receptek.co.uk

**Head Office**

Receptek, Estate Road 2,  
South Humberside Industrial Estate,  
Grimsby, DN31 2TG

---