

receptek

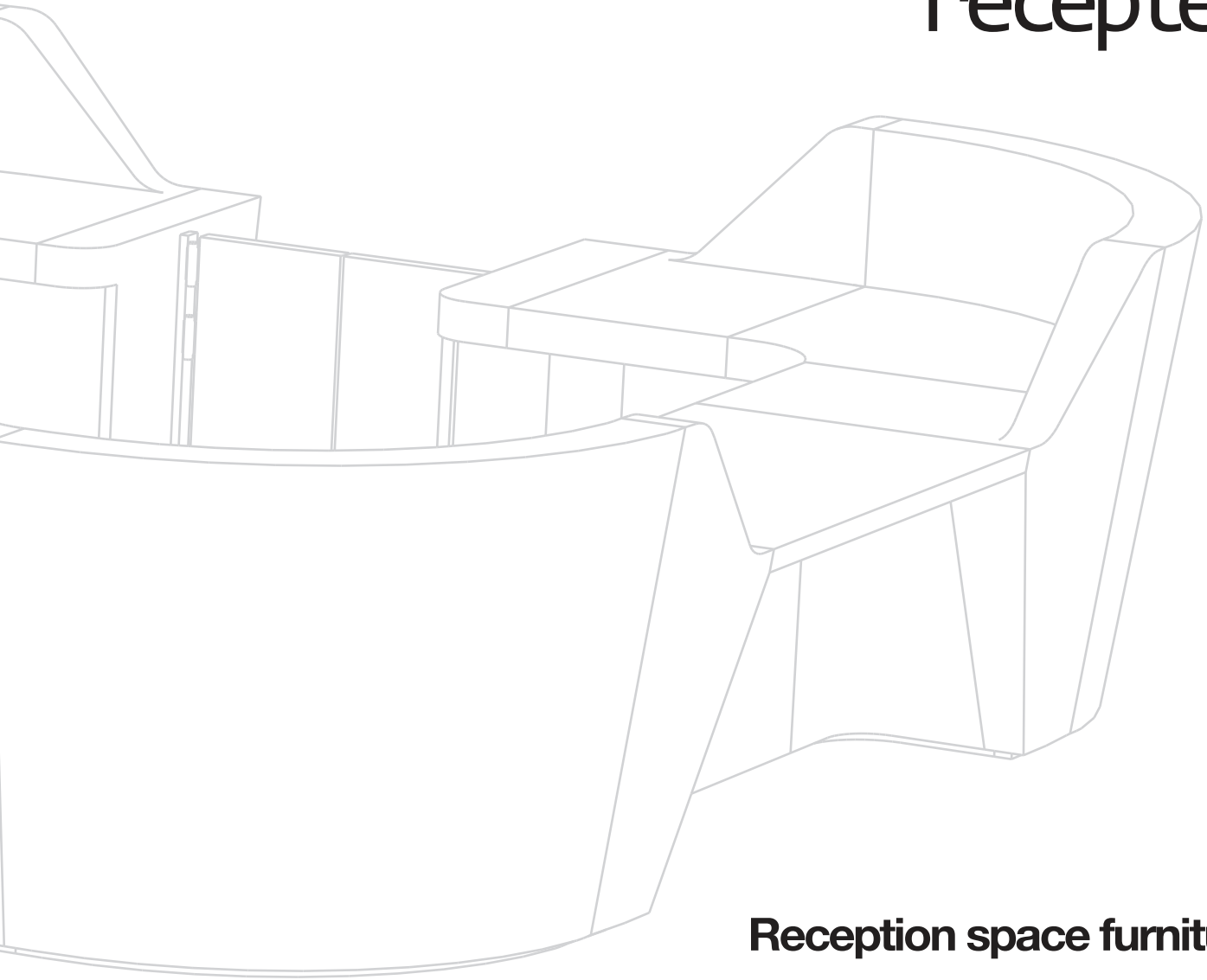

Reception space furniture

ZENON

Striking, simple, abstract, Zenon is an all new product suited to any environment – healthcare, leisure, workplace.

Zenon has a “tum te tum” about it that a typically busy reception needs. The use of lighting in an abstract fashion lifts the morale. With any RAL colour available in the Spray Lacquered option the future is bright!

Designers Comment:

“I love this product. Modern lighting products have really opened up a new dimension for designers whilst not blowing the budget!”

Key features

Solid Surface Material (Corian)

Spray Lacquered

Laminated MDF

Modular on specification, seamless on installation

Easy to specify modular components CAD and BIM files available

Three height options of 750 mm and 1100 mm as standard

DDA modules available

Branding, sign-in platform and storage units available as options

LED light trough

Various colour options available

Available in 4–6 weeks

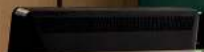

uclh
Safety
Kindness
Teamwork
Improving



Zenon Typical Configurations & Modules

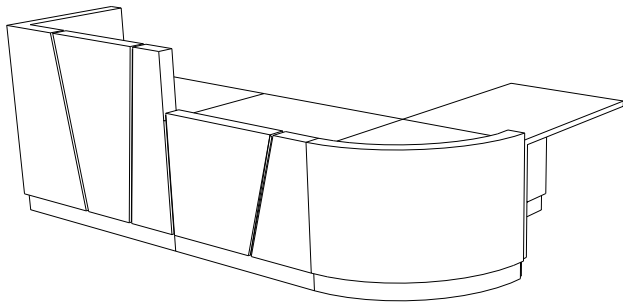

Example 1
Made up of modules; Z-EMH1 / 1250, Z-MML / 1000,
Z-LRCE / 750, Z-DDA / 1000

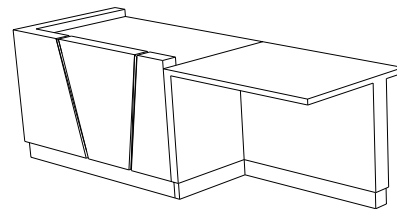

Example 2
Made up of modules; Z-EML1 / 1250, Z-DDDA / 1000

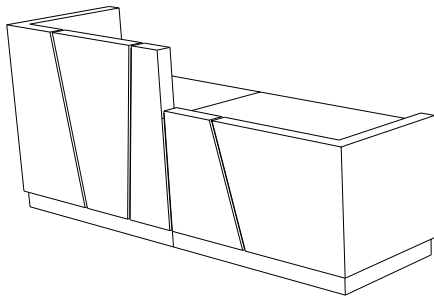

Example 3
Made up of modules; Z-EMH1 / 1250, Z-EML2 / 1450

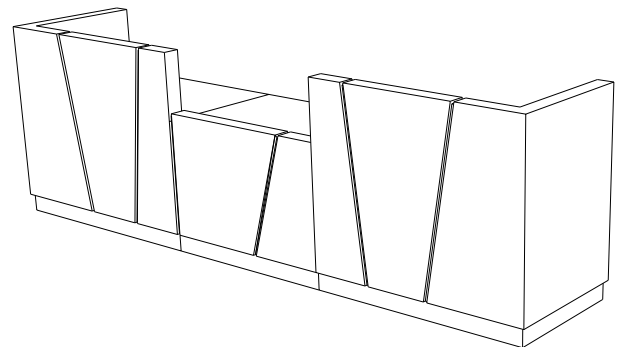

Example 4
Made up of modules; Z-EMH1 / 1250, Z-MML / 1000, Z-EMH2 / 1250

Zenon Modules

Left hand modules

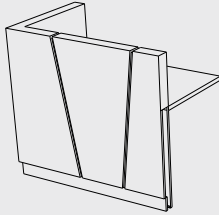

Module Name: **Left Hand High Module 1250**
Module Code: **Z-EMH1 /1250**
Module Size: **1205x750x1100mm**

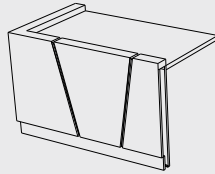

Module Name: **Left Hand Low Module 1250**
Module Code: **Z-EML1 /1250**
Module Size: **1205x750x800mm**

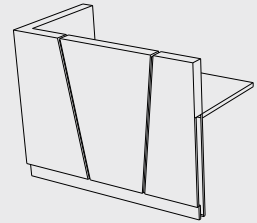

Module Name: **Left Hand High Module 1450**
Module Code: **Z-EMH1 /1450**
Module Size: **1450x750x1100mm**

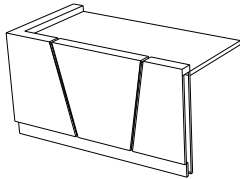

Module Name: **Left Hand Low Module 1450**
Module Code: **Z-EML1 /1450**
Module Size: **1450x750x800mm**

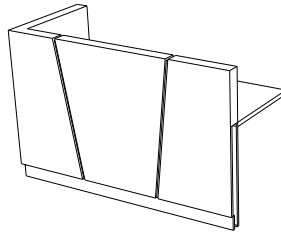

Module Name: **Left Hand High Module 1750**
Module Code: **Z-EMH1 /1750**
Module Size: **1750x750x1100mm**

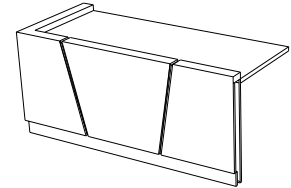

Module Name: **Left Hand Low Module 1750**
Module Code: **Z-EML1 /1470**
Module Size: **1750x750x800mm**

Right hand modules

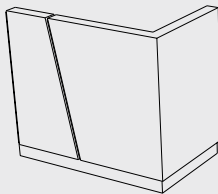

Module Name: **Right Hand High Module 1250**
Module Code: **Z-EMH2 /1250**
Module Size: **1205x750x1100mm**

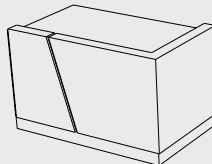

Module Name: **Right Hand Low Module 1250**
Module Code: **Z-EML2 /1250**
Module Size: **1205x750x800mm**

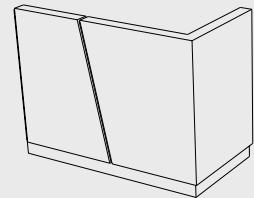

Module Name: **Right Hand High Module 1450**
Module Code: **Z-EMH2 /1450**
Module Size: **1450x750x1100mm**

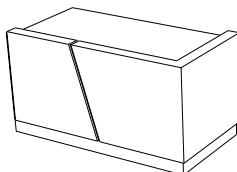

Module Name: **Right Hand Low Module 1450**
Module Code: **Z-EML2 /1450**
Module Size: **1450x750x800mm**

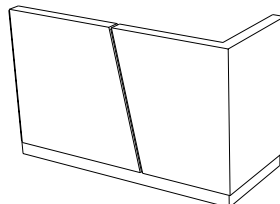

Module Name: **Right Hand High Module 1750**
Module Code: **Z-EMH2 /1750**
Module Size: **1750x750x1100mm**

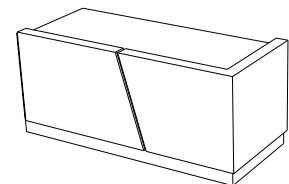

Module Name: **Right Hand Low Module 1750**
Module Code: **Z-EML2 /1470**
Module Size: **1750x750x800mm**

Zenon Modules

Intermediate modules

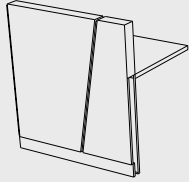

Module Name: **Middle High Module 1000**
Module Code: **Z-MMH / 1000**
Module Size: **1000x750x1100**

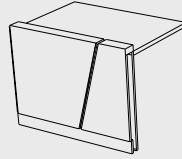

Module Name: **Middle Low Module 1000**
Module Code: **Z-MML / 1000**
Module Size: **1000x750x800**

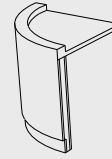

Module Name: **Low Left Curved End**
Module Code: **Z-LLCE / 750**
Module Size: **750x750x800**

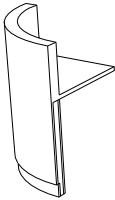

Module Name: **High Left Curved End**
Module Code: **Z-HLCE / 750**
Module Size: **750x750x1100**

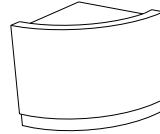

Module Name: **Low Right Curved End**
Module Code: **Z-LRCE / 750**
Module Size: **750x750x800**

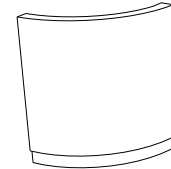

Module Name: **High Right Curved End**
Module Code: **Z-HRCE / 750**
Module Size: **750x750x1100**

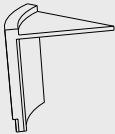

Module Name: **Low Left Semi Curved End**
Module Code: **Z-LLSCE / 750**
Module Size: **750x750x800**

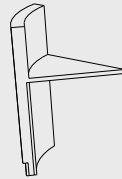

Module Name: **High Left Semi Curved End**
Module Code: **Z-HLSCE / 750**
Module Size: **750x750x1100**



Module Name: **Low Right Semi Curved End**
Module Code: **Z-LRSCE / 750**
Module Size: **750x750x800**



Module Name: **High Right Semi Curved End**
Module Code: **Z-HRSCE / 750**
Module Size: **750x750x1100**

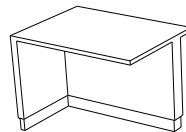

Module Name: **Block Light DDA Section**
Module Code: **Z-DDA / 1000**
Module Size: **1000x750x750**





Products





Products



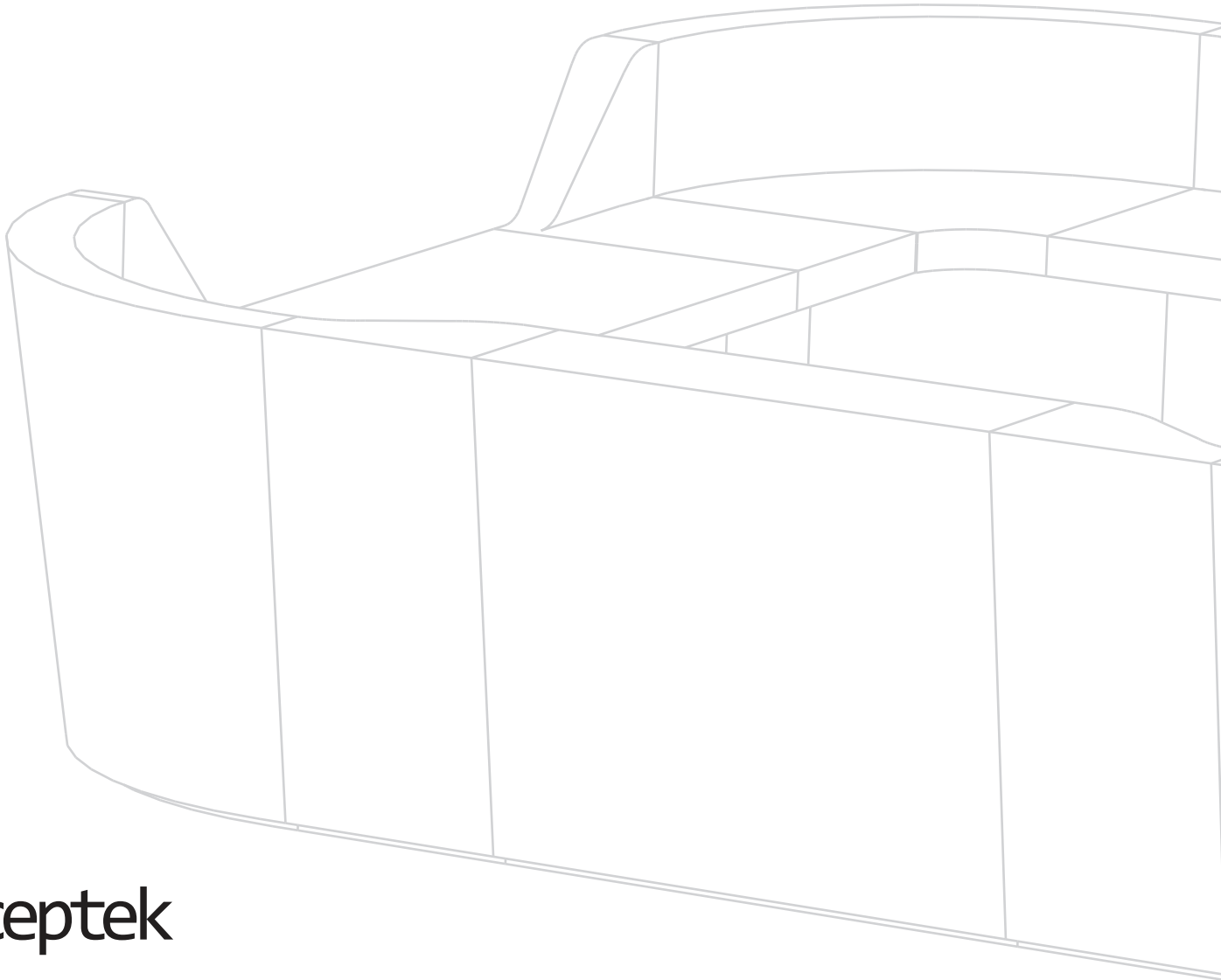

receptek

Contact Us

+44(0)1472 360 111
hello@receptek.co.uk
www.receptek.co.uk

Head Office

Receptek, Estate Road 2,
South Humberside Industrial Estate,
Grimsby, DN31 2TG
